



## DELUXE DROP-IN SERIES OUTDOOR GAS BARBECUE

### INSTALLATION AND OPERATING INSTRUCTIONS

**INSTALLER:** Leave these instructions with consumer.

**CONSUMER:** Retain for future reference.



(Optional vent hood shown)

**Important:** READ THESE INSTRUCTIONS CAREFULLY BEFORE STARTING INSTALLATION OR USE.

### SAFETY WARNINGS & CODES

#### **⚠ DANGER**

##### **IF YOU SMELL GAS:**

1. Shut off the gas to the appliance.
2. Extinguish any open flame.
3. Open lid if equipped with an oven.
4. If odor continues, keep away from the appliance, and immediately call the gas supplier or the fire department.

#### **⚠ WARNING**

1. Do not store or use gasoline or other flammable vapors and liquids in the vicinity of this or any other appliance.
2. A propane cylinder, not connected for use, shall not be stored in the vicinity of this or any other appliance.

#### **⚠ WARNING**

Improper installation, adjustment, alteration, service, or maintenance can cause injury or property damage. Refer to this manual. For assistance or additional information, consult a qualified professional installer, service agency, or the gas supplier.

**CODE AND SUPPLY REQUIREMENTS:** This barbecue must be installed in accordance with local codes and ordinances, or, in the absence of local codes, with either the latest *National Fuel Gas Code (ANSI Z223.1/NFPA 54)*, or *Natural Gas and Propane Storage and Handling Installation Code (CSA-B149.1)*.

This appliance and its individual shutoff valves must be disconnected from the gas supply piping system when testing the system at pressures in excess of ½ psig (3.5 kPa).

This appliance must be isolated from the gas supply piping system by closing its individual manual shutoff valves during any pressure testing of the gas supply system at pressures up to and including ½ psig (3.5 kPa).

All electrical outlets in the vicinity of the barbecue must be properly grounded in accordance with local codes, or, in the absence of local codes, with the *National Electrical Code, ANSI/NFPA 70*, or the *Canadian Electrical Code, CSA C22.1*, whichever is applicable.

Keep all electrical supply cords and fuel supply hoses away from any heated surface.



Robert H. Peterson Co. • 14724 East Proctor Avenue • City of Industry, CA 91746

## TABLE OF CONTENTS

1	SAFETY WARNINGS & CODES
2	TABLE OF CONTENTS
2	PRODUCT DATA TABLE
3	PARTS LIST
4	PLANNING FOR INSTALLATION
4	ENSURING PROPER COMBUSTION AIR AND COOLING AIR FLOW
4	ELECTRICAL OUTLETS
4	EXHAUST REMOVAL
4	GAS SUPPLY PLUMBING REQUIREMENTS
4	DRIP TRAY ACCESS
5	INSTALLATION
5	CHECK BARBECUE FUEL ORIFICE SIZE
5	CONNECT THE GAS SUPPLY TO BARBECUE
5	INSTALL THE FLAVOR GRID
6	SAFE USE & MAINTENANCE OF PROPANE GAS CYLINDERS
7	CHECKING AND CONVERTING GAS TYPE
7	CHECKING AND CONVERTING THE REGULATOR
8	AIR SHUTTER ADJUSTMENT
8	MAIN BURNER AIR SHUTTER ADJUSTMENT
9	BARBECUE SAFETY INFORMATION & MAINTENANCE
9	DRIP COLLECTION SYSTEM
10	LIGHTING INSTRUCTIONS
11	ACCESSORIES
11	THE FLAVOR GRID(S)
11	THE WARMING RACK
12	CARE & CLEANING
13	TROUBLESHOOTING
14	WARRANTY

## PRODUCT DATA TABLE

Specification	Value
<b>Counter opening height*</b>	<b>12" (30.5 cm)</b>
<b>Counter opening width*</b>	<b>24 1/4" (61.2 cm)</b>
<b>Counter opening depth*</b>	<b>19 1/4" (48.3 cm)</b>
<b>Main burner</b>	
BTU per burner	<b>42,000 (12.4 kw) x 2</b>
Natural gas orifice	<b>#44 (2.184 mm)</b>
Propane gas orifice	<b>#55 (1.321 mm)</b>
<b>Infrared burner</b>	
BTU per burner	<b>28,000 (8.2 kw)</b>
Natural gas orifice	<b>#53 (1.511 mm)</b>
Propane gas orifice	<b>#58 (1.067 mm)</b>

**Table 1** - Product data table

**\*Note:** If using an insulating liner consult liner instructions for counter cut-out dimensions.

## PARTS LIST

Item	Description
1.	Valve knob
2.	Ignitor knob
3.	Flavor grid
4.	Drop-in liner
5.	Drip tray
6.	Drop-in shell
7.	Pair of air shutters
8.	Pair of steel burners
9.	Pair of air shutter springs
10.	Pair of orifices (natural) or Pair of orifices (propane)
11.	Pair of orifice holders
12.	Manifold assembly
13.	Top control panel
14.	Stainless steel grid
15.	Oven assy. (optional)
16.	Electrode assy with wiring

Replacement parts can be ordered from your local Fire Magic dealer.

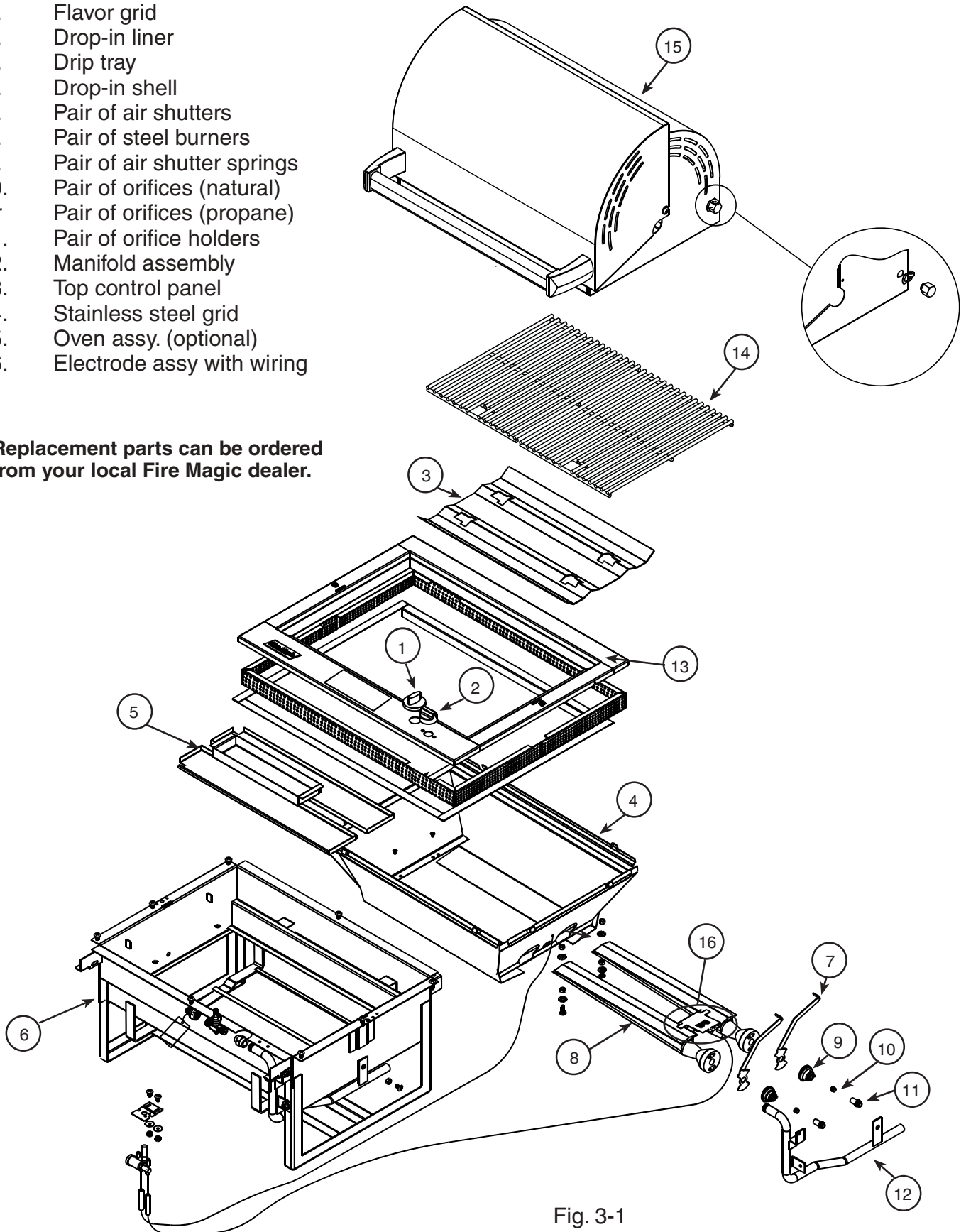

Fig. 3-1

# PLANNING FOR INSTALLATION

## WHERE TO INSTALL THE BARBECUE

Fire Magic barbecues are designed for outdoor use only.

### WARNING

Drop-in models must be installed in masonry or other type of fireproof surroundings. This unit is not insulated and must be installed with a clearance from combustible materials of 18" (45.7 cm) on the sides and the back. This appliance shall not be located under unprotected overhead combustible construction.

With our insulating liner, you can safely install the Fire Magic barbecue in a wood cabinetry, stucco, or other combustible enclosure.

**Do not install this unit under unprotected flammable surfaces. Do not install or use this appliance inside a building, garage, or any other enclosed area, including recreational vehicles or boats.**

**Note:** This barbecue must be installed so that it can be removed in the event service should be necessary. Any protrusion into the barbecue enclosure from either side, which is less than 11<sup>1</sup>/<sub>4</sub>" (28.2 cm) below the countertop, may obstruct the frame and prevent the unit from dropping into place.

## ENSURING PROPER COMBUSTION AIR AND COOLING AIR FLOW

The 1/2" (1.27 cm) vent space between the top panel of the unit and the countertop that is created by the attached cork mounting pads resting on the countertop must be left clear. Blockage of barbecue air flow causes overheating and poor combustion. A vent screen is provided to cover this opening.

## ELECTRICAL OUTLETS

Electrical outlets in the vicinity of the barbecue, which might be used for rotisserie motors or other appliances, must be properly grounded.

**Note:** Keep electrical supply cords away from all heated surfaces.

## EXHAUST REMOVAL

If installed under a patio roof, the cooking grid area must be fully covered by a chimney and exhaust hood. An exhaust fan with a rating of at least 1,000 CFM (472 liters per second) or more may be necessary to efficiently remove smoke and other cooking by-products from the covered area. Do not install in a fully enclosed area of any kind.

## GAS SUPPLY PLUMBING REQUIREMENTS

Rigid 1<sup>1</sup>/<sub>2</sub>" (1.27 cm) black steel pipe is required to conduct the gas supply into the barbecue enclosure for connection to the unit. Pipe joint compound that is resistant to all gasses should be applied to all male fittings and all joints tightened securely. Do not use pipe joint compound to connect flare fittings.

The pipe should terminate near the front and center of the enclosure, no more than 5" (12.7 cm) from the countertop. Installation will be simplified if the pipe enters the enclosure vertically from the bottom, at least 6" (15.2 cm) in from each

side, and within 8" (20.3 cm) of the front wall (Fig. 4-1).

If the pipe does not come up against the front wall, it can easily be run along the enclosure floor and turned up to rise within 5" (12.7 cm) of the countertop, tight against the front wall (leaving space only to connect fittings, Fig. 4-2).

**Note:** An external valve in the gas line is necessary for safety when the barbecue is not in use. It also provides for convenient maintenance and repair. A removable key is recommended.

## GAS SUPPLY AND MANIFOLD PRESSURE:

For **natural gas** - Normal 7" (17.8 cm) w.c. (water column), minimum 5" (12.7 cm), maximum 10<sup>1</sup>/<sub>2</sub>" (26.7 cm).

For **propane gas** - Normal 11" (27.9 cm) w.c., minimum 8" (20.3 cm), maximum 13" (33 cm).

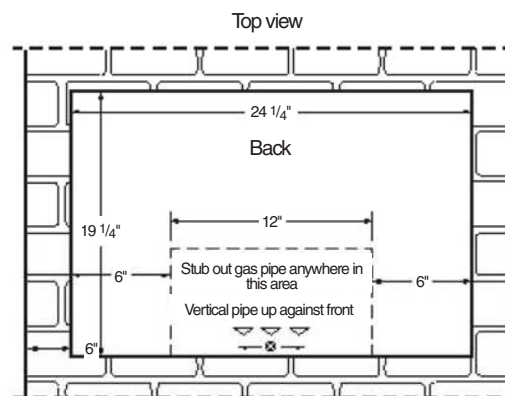

Fig. 4-1 - Top view

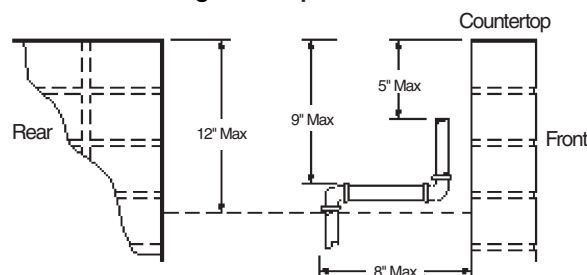

Fig. 4-2 - View from left

**CAUTION:** Wind blowing into or across the rear oven lid vent can cause poor performance and/or dangerous overheating. Orient the grill so that the prevailing wind blows toward the front of the grill (Fig. 4-3).

**CAUTION:** To prevent dangerous overheating, the rear of the unit must have a minimum clearance of 8" from any backsplash/wall.



Fig. 4-3

## DRIP TRAY ACCESS

If the grill is being installed next to the left wall of the enclosure, a 6" (15.3cm) clearance from the left wall (or any appliances) is required to properly remove the drip trays through the top of the unit. See the BARBECUE SAFETY INFORMATION & MAINTENANCE section for installation/removal.

# INSTALLATION

Perform the following checks before installing the barbecue:

## CHECK BARBECUE FUEL ORIFICE SIZE

This barbecue comes from the factory configured for one type of gas as marked on the label behind the barbecue face plate. Each burner uses a different orifice depending on the gas used in the barbecue. Please refer to Table 1 for the correct orifice size.

1. Remove the cooking grids and flavor grid from the barbecue.
2. If the gas supply has been connected, make sure the burner valve is in the **OFF** position. Then pull the knobs from their stems. Use a Phillips screwdriver to turn the face fastener screws counterclockwise to release the face and remove it from the barbecue. Make sure to retain the screws and finish washers until you are ready to reattach the face.

**Note:** Carefully lift the face away from the frame. The spark generators for the ignition system are attached to the inside of the face panel. The spark generator need not be detached, but the wires must be unplugged from the generators before the face is removed.

3. Using a flat-blade screwdriver, pry the burner retaining clip from rear wall of the barbecue frame (see Fig. 5-1). Remove the burner by: 1) Pulling it to the front of the barbecue, 2) Lifting the far end out of the notch, 3) Pulling the burner away from the manifold, taking care not to lose the air shutter and spring, which may become detached when the burner is removed.
4. Using a  $\frac{3}{8}$ " socket, remove orifice from the orifice holder on the burner manifold and check the number stamped on the face (see barbecue fuel orifice size in Table 1). Repeat for each burner as necessary.
5. Replace the orifice with an orifice of the proper drill size as listed in the PRODUCT DATA TABLE.
6. After checking the orifice drill size or replacing the orifice, install the air shutter spring and the air shutter over the orifice holder fitting, between the burner and the burner manifold, in the order and position shown in Fig. 5-1.
7. Replace the burners in the holding groove, ensuring that the brass orifice and orifice holder fittings project deeply into the burners. Replace the burner retaining clips.

**WARNING:** It is critical to the continued safe operation of the burner that it be properly aligned with the orifice, as indicated above.

## CONNECT THE GAS SUPPLY TO BARBECUE

**CAUTION:** Use only stainless steel flex connectors that are C.S.A. listed.

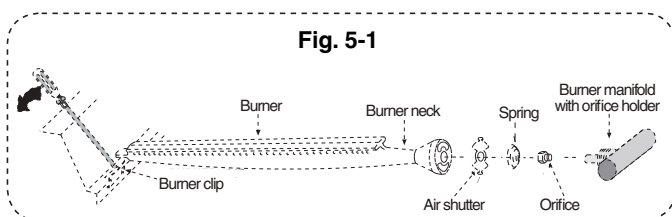

**WARNING:** A rubber or plastic connector will rupture or leak, resulting in an explosion or serious injury if used inside the barbecue enclosure.

1. Make sure that the gas supply is turned **OFF**. Then connect the  $\frac{1}{2}$ " (1.27 cm) pipe adapter fitting supplied with the stainless steel flex connector to the gas supply stub. Use pipe joint compound that is resistant to all gasses or Teflon tape on all male pipe fittings and tighten securely. Do not use pipe joint compound to connect brass flare fittings.
2. Lower the barbecue into place, making sure not to pinch or kink the gas connector. The unit may be supported above the counter by blocks inserted under the flanges at each side of the frame (Fig. 5-2).
3. If the pipe does not come up against the front wall, it can easily be run along the enclosure floor and turned up to rise within 5" (12.7 cm) of the countertop, tight against the front wall (leaving space only to connect fittings).
4. Connect the flex connector to the flare fitting on the manifold inlet. Support the manifold inlet fitting with a wrench to avoid applying excessive torque to the manifold assembly while tightening this connection securely. Do not use pipe compound on flare fittings.

Make sure the barbecue burner valve is in the **OFF** position. Turn the gas supply on. Then carefully check all gas connections for leaks with a brush and soapy water before lighting. **NEVER USE A MATCH OR OPEN FLAME TO TEST FOR LEAKS.**

5. Refer to the AIR SHUTTER ADJUSTMENT instructions before replacing barbecue face and knobs.

## INSTALL THE FLAVOR GRID

Place the flavor grid directly on the burners (Fig. 5-3). Center the grid over the burners with the open side up. This allows heat from the burners to be evenly distributed throughout the cooking area. The flavor grid heats and cools quickly, making your Fire Magic barbecue very responsive to the changes you specify in grill temperature.

The flavor grid is made of stainless steel and is rust resistant. It may be cleaned with standard oven cleaners.

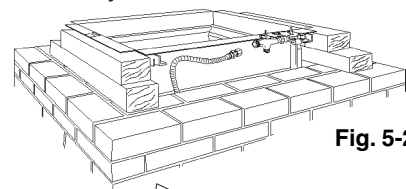
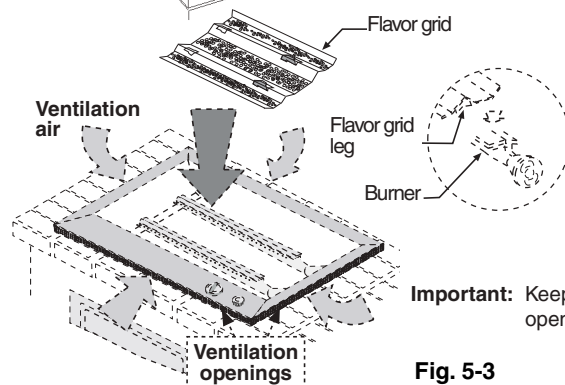

Fig. 5-2



**Important:** Keep ventilation openings clear.

Fig. 5-3

# SAFE USE & MAINTENANCE OF PROPANE GAS CYLINDERS

## IMPORTANT FOR YOUR SAFETY

### READ AND FOLLOW ALL WARNINGS PROVIDED WITH THE PROPANE-GAS CYLINDER.

When operating this appliance with a propane-gas cylinder, these instructions and warnings **MUST** be observed.

**FAILURE TO DO SO MAY RESULT IN A SERIOUS FIRE OR EXPLOSION.**

## CYLINDER/CONNECTOR REQUIREMENTS

- Propane-gas cylinders, valves, and hoses must be maintained in good condition and must be replaced if there is visible damage to either the cylinder or valve. If the hose is cut or shows excessive abrasion or wear, it must be replaced before using the gas appliance (see e.).
- This unit, when used with a cylinder, should be connected to a standard 5-gallon (20 lb.) propane-gas cylinder equipped with an OPD (Overfill Prevention Device). The OPD has been required on all cylinders sold since October 1, 1998, to prevent overfilling.
- Cylinder dimensions should be approximately 12" (30.5 cm) in diameter and 18" (45.7 cm) high. Cylinders must be constructed and marked in accordance with the *Specifications for Propane Gas Cylinders of the U.S. Department of Transportation (D.O.T.)* or the National Standard of Canada, *CAN/CSA-B339, Cylinders, Spheres, and Tubes for Transportation of Dangerous Goods*.
- The cylinder used must include a collar to protect the cylinder valve, and the cylinder supply system must be arranged for vapor withdrawal.
- The pressure regulator and hose assembly (Fig. 6-1) supplied with this outdoor gas appliance (select L.P. models only) must be used. Original and replacement pressure regulator and hose assemblies must be those specified by the manufacturer for connection with a cylinder connecting device identified as Type I by the *ANSI Z 21.58-2005/CGA 1.6-2005* (see PARTS LIST for ordering information).
- The propane-gas cylinder valve must be equipped with a cylinder connection coupling device, described as Type I in the standard defined in paragraph e. above. This device is commonly described as an Acme thread quick coupler.
- If the propane-gas cylinder comes with a dust plug, place the dust cap on the cylinder valve outlet whenever the cylinder is not in use.

## QUICK COUPLER OPERATION

**To connect the regulator/hose assembly to the propane-gas cylinder valve fitting:** Press the hand nut on the regulator over the Acme thread fitting on the cylinder valve. Turn the hand nut clockwise to engage the threads and tighten until snug.

## ENCLOSURE REQUIREMENTS

**FOR YOUR SAFETY, you must provide the openings listed below for drainage, replacement air, and cross-ventilation of any storage area exposed to possible leakage from gas connections, the unit, or propane cylinders.**

**One side of the enclosure can be left completely open to the outside, OR 4 ventilation openings must be created:**

**Two of the openings are to be at the cylinder valve level (approx. 16" above the floor) and on opposite walls of the enclosure. 2 more openings must be at the floor level (approx. 5" above the floor) and on opposite sides of the enclosure. Each opening must have a minimum of 10 sq. in. of free area. To achieve the proper ventilation, you may drill a series of holes, omit the grout from masonry joints, or replace a brick with a hardware cloth screen. If the floor in the cabinet is raised and the space beneath the cabinet is open to the outside, the lower ventilation openings may be in the floor.**

**Consult your gas supplier for ventilation and regulator requirements when connecting to a household propane supply.**

The use of pliers or a wrench should not be necessary. Only cylinders marked "propane" may be used.

**To disconnect:** Turn the hand nut counterclockwise until detached (Fig. 6-1).

**Important:** Before using the unit, and after each time the cylinder is removed and reattached, check the hose for wear (see a.) and check all connections for leaks. Turn off the unit valves and open the main cylinder valve, then check connections with soapy water. Repair any leaks before lighting the unit.

**CAUTION:** Always turn the propane cylinder main valve off after each use, and before moving the unit and cylinder or disconnecting the coupling. This valve must remain closed and the cylinder disconnected while the appliance is not in use, even though the gas flow is stopped by a safety feature when the coupler is disconnected.

**Carefully** inspect the hose assembly each time before the gas is turned on. A cracked or frayed hose must be replaced immediately.

If the appliance is stored indoors, the cylinder must be disconnected and removed. Disconnected cylinders must be stored outdoors, out of the reach of children, with threaded valve plugs tightly installed, and must not be stored in a building, garage, or any other enclosed area.

## FOR YOUR SAFETY

- DO NOT store a spare propane-gas cylinder under or near this appliance.
- NEVER fill the cylinder beyond 80-percent full.
- IF THE INFORMATION IN a. AND b. IS NOT FOLLOWED EXACTLY, A FIRE CAUSING DEATH OR SERIOUS INJURY MAY OCCUR.

**Fig. 6-1 Type I Acme thread quick coupler**

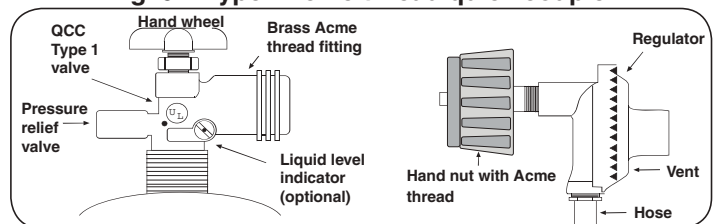

## CHECKING AND CONVERTING GAS TYPE

This unit comes from the factory configured for one type of gas, as marked on the label located behind the control panel, or on the interior of the unit's enclosure.

**Converting this unit to burn a different type of gas requires a conversion kit (contact your dealer for details). The professional installer who converts this unit to burn a different gas must perform the following functions:**

1. Change brass gas orifices (included at original shipping) on each burner to match the new gas type (see PRODUCT DATA TABLE, Table 1).
2. Switch the convertible gas regulator (if equipped) to match the new gas type (see section below).
3. Plumb the unit as appropriate for the new gas supply.
4. Apply the label for the new gas (included at original shipping) over the old gas information found on your unit.

### **WARNING**

**HAZARDOUS OVERHEATING WILL OCCUR IF A NATURAL-GAS ORIFICE IS USED WITH PROPANE GAS. IF YOU ARE NOT SURE IF THE CORRECT ORIFICES ARE INSTALLED, OR IF AN ORIFICE CHANGE IS NECESSARY, REFER TO THE FOLLOWING INSTRUCTIONS.**

**CAUTION:** Make sure the unit is at a safe temperature and isolated from gas and electrical supplies before beginning the tasks outlined below.

**Note:** The cooler the unit, the greater the tolerances between the stainless-steel parts, and therefore the easier to disassemble and reassemble parts of the unit.

**CAUTION:** For your safety, exercise caution and use adequate hand protection (such as gloves) when handling potentially sharp sheet-metal parts.

## CHECKING AND CONVERTING THE REGULATOR

Regulator: note cap on top

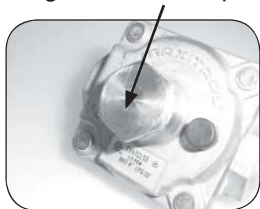

**Note:** Each end of the plastic converter is engraved with either the letters "NAT" or "L.P." (propane) for the respective gasses. When the converter is in the cap and the cap is held uppermost, the letters seen indicate the gas that the regulator is set up for.

To convert the regulator from one gas to another, follow steps 1-4.



**STEP 1:**  
Unscrew and remove the cap from the regulator, extracting the converter.



Read gas type here

**STEP 3:**  
Turn the converter around and replace it carefully, into the center of the cap (it will snap into place). Check that you can read the type of gas the unit is set for.



**STEP 2:**  
Remove the converter (the plastic stalk) by carefully pulling it away from the center of the cap (it will snap out of its seating).



**STEP 4:**  
Replace the unit into the regulator and screw down until snug.

### **WARNING**

THIS APPLIANCE REGULATOR IS RATED FOR 1/2 PSI MAXIMUM. IF YOUR GAS SUPPLY IS GREATER THAN 1/2 PSI, AN ADDITIONAL REGULATOR MUST BE INSTALLED TO REDUCE THE INPUT PRESSURE TO THE UNIT TO 1/2 PSI OR LESS. SEE GAS-SUPPLY REQUIREMENTS SECTION FOR PROPER GAS-SUPPLY PRESSURE.

## AIR SHUTTER ADJUSTMENT

### MAIN BURNER AIR SHUTTER ADJUSTMENT

**Important:** The air shutters must be adjusted after installation. If not, this appliance may not light, heat evenly, or cook properly.

Main burner air shutters are controlled by the two wire levers at the far right side of the cooking grill (see PARTS LIST). The air shutter has a small dimple (see Fig. 8-1) that allows it to lock into notches in the burner face. This prevents the air shutter from moving.

1. **Using the two, long air shutter levers**, close the air shutters by turning the tabs to a vertical position (Fig. 8-2).
2. Light the barbecue in accordance with the LIGHTING INSTRUCTIONS and burn for two minutes with the knobs on **HI LIGHT** and the oven open.
3. After burning for two minutes, open the air shutters, **using the air shutter levers**, until the flames lift off, or appear not to be touching the burners (Fig. 8-1).
4. Begin closing the air shutters, **with the air shutter levers**, until the flames appear to burn while touching the burner ports (Fig. 8-2).

**Note:** You may then see short yellow tips on the flames. If flames are a lazy yellow, open the air shutters until the flame is blue with yellow tipping.

**Note:** Barbecues, in some installations, achieve a better air/gas mixture and will ignite more quickly if the valve is first turned beyond **HI LIGHT** to **LOW** for lighting.

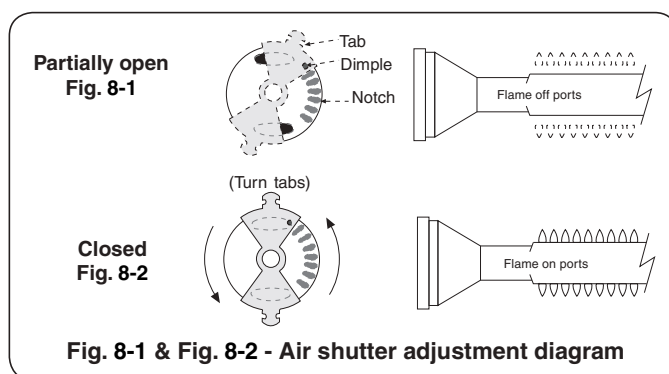



## BARBECUE SAFETY INFORMATION & MAINTENANCE

### Each time you use the barbecue, make sure that:

1. The area around the barbecue is clear of flammable vapors, liquids, and substances such as gasoline, yard debris, wood, etc.
2. There is no blockage of the airflow through the vent space located below the face of the unit.
3. When using propane gas:
  - a. The special ventilation openings in the enclosure should be kept free and clear of debris (see **PLANNING THE LOCATION OF THE BARBECUE**).
  - b. If connected to a propane cylinder, the rubber hose attached to the regulator should be carefully inspected before each use.
  - c. The propane cylinder, regulator, and rubber hose should be installed in a location not subject to heating above 125° F (51° C).
4. The burner flames burn evenly along both sides of each burner with a steady flame, which is mostly blue. (Refer to section on **AIR SHUTTER ADJUSTMENT**.) A proper flame pattern will ensure safe operation and optimal performance. Adjust the air shutter as needed. If burner flames are not normal, check the orifice and burner for insects or insect nests.
5. The inline gas valve or gas cylinder valve is always shut **OFF** when the barbecue is not in use.
6. The drip collector hole is clear and unobstructed. Excessive grease deposits can result in a grease fire.
7. The barbecue is free and clear from combustible materials, gasoline, and other flammable vapors and liquids.

### DRIP COLLECTION SYSTEM

The drip collector in this barbecue is part of the unit's main frame and is located below the burners. The drip collector has slots that will allow excess drippings to fall through during cooking, while separating the firebox from the drip tray. Clean the drip tray after each use.

The drip collector allows you to brush or scrape residue from the barbecue's inner liner into the drip tray. Following the manufacturer's instructions and regular cleaning of the barbecue's interior with oven cleaner, will help to prevent grease fires.

Periodically check the burners to make sure they are clear of debris. Properly adjusted burner flames burn evenly along both sides of each burner with a steady flame (mostly blue). If burner flames are not normal, check the orifice and burner for insects or insect nests. (See section on **CHECKING/CONVERTING THE BURNER ORIFICES** for instructions on burner removal and replacement.)

Check the burner ports at least annually for blockage by removing the burner (see orifice changing instructions) and visually inspect the gas intake tube for insects and nests. A clogged tube can lead to a fire beneath the grill.

### SERVICING THE DRIP COLLECTION SYSTEM

#### The grill must be completely cool and gas shut off.

Remove the cooking grids and flavor grid. To remove a tray, lift and slide the tray to the left and pull out from between the two burners as shown in Fig. 9-1.

When re-installing, the bottom drip tray must be placed to the far left of the grill to catch any contents draining from the top trays. Ensure the top tray with the tab is properly placed over the other top tray. See Fig. 9-1.

Re-install the flavor grid and cooking grids.



### **WARNING**

**NEVER** cover the entire cooking or grill surface with griddles or pans. Overheating will occur and burners will not perform properly when combustion heat is trapped below the cooking surface.

**CAUTION:** NEVER spray water on a hot gas unit.

## LIGHTING INSTRUCTIONS

Follow these instructions each time you light your Fire Magic® barbecue.

### FOR AUTOMATIC LIGHTING

1. Read these instructions before lighting.
2. Open the lid of the smoke oven.
3. Turn both barbecue gas valves to the **OFF** position.
4. Turn on the gas at the source outside of the barbecue enclosure.

**Note:** **DO NOT** turn on more than one valve at a time for either automatic or manual lighting. Adjacent barbecue burners will cross-ignite.

5. Depress the desired gas valve and turn to **HIGH**, then immediately turn the light knob several times in the direction of the arrows.

**CAUTION:** If the burners do not light, **IMMEDIATELY** turn the valve to **OFF** and **WAIT 5 MINUTES** before repeating step 5. If the burners still do not light, refer to the instructions below for manual lighting.

**Note:** Barbecues in some installations achieve a better air/gas mixture and **will ignite more quickly** if the valve is first turned beyond **HIGH** to **MEDIUM** or **LOW** for lighting.

### FOR MANUAL LIGHTING

**CAUTION:** Always wait 5 minutes for gas to clear after any unsuccessful lighting attempt.

**Follow steps 1 through 4 above.**

5. Insert either a burning long-barrel butane lighter, a burning long-stem match, or a burning match held by a wire extension holder through the cooking grids to the burners below the flavor grid.
6. While holding the match or lighter flame next to the burner, depress the appropriate valve knob and turn it counter-clockwise to the **HIGH** position. Adjacent burners will cross-ignite.

7. If the burner does not light, **IMMEDIATELY** turn the valve to **OFF** and **WAIT 5 MINUTES** before repeating steps 5 through 7 of the **MANUAL LIGHTING INSTRUCTIONS**.

*Replacement parts may be obtained from your nearest Fire Magic® dealer. For assistance in locating a dealer, please contact our factory at the address listed on the cover.*

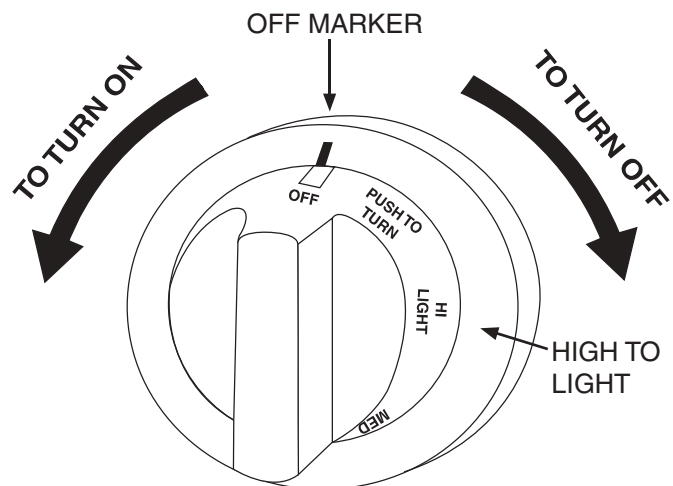

Fig. 10-1 - Valve control knob



Fig. 10-2 - Match holder

**REMEMBER:** For safe manual lighting, place a burning match or butane lighter beside the burner - **Then turn on the gas** (Fig. 10-3).

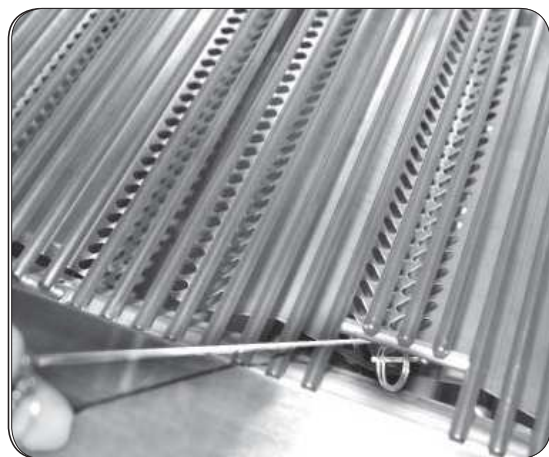

Fig. 10-3 - Manual lighting

## ACCESSORIES

### GRILL BRUSH (optional)

Purchase a Fire Magic® stainless-steel grill brush (sold separately) to keep your grill cleaner. It comes with scraper for large particles and a replaceable head with brass bristles for overall cleaning.



Fig. 11-1

Grill brush with replacement head

### WARMING RACK (if equipped)

The warming rack (Fig. 11-2) is packed separately.

To install the warming rack, lift the front of the rack up slightly and insert the rack hangers into the two holes in the back of the inner oven hood. Then lower the front of the rack into a level position to lock the rack in place.

To remove the warming rack, lift up on the front of the rack until the rack hangers pull free from their supporting holes.

**Note:** Removing the warming rack before using the rotisserie will leave more clearance for the meat being cooked. (if applicable)

### THE COOKING GRID LIFTER

Hold the grid lifter by gripping the center section with the prongs pointing down (use an oven mitt or heavy glove if the grill is hot). Insert the notched end of the grid lifter into the cooking grid, in front of the midway point (front to back; Fig. 11-3), and central (left to right; Fig. 11-4). Twist the grill lifter (clockwise or counterclockwise) so the handle is parallel to the grill rods. This “seats” the spiked end of the grid lifter between two rods, enabling you to safely lift out the grid. Lift slowly and adjust the grid lifter, if necessary, for balance.

### THE DRIP TRAY

The drip collection system allows you to brush or scrape excess dried residue from the grilling area directly into the drip tray (see PARTS LIST for drip tray location).

### THE FLAVOR GRID(S)

Place each flavor grid directly over a burner or burner pair. Center each grid over the burner, oriented as shown in Fig. 11-5.

**Note:** This allows heat from the burners to be evenly distributed throughout the cooking area. The flavor grids heat and cool quickly, making the grill very responsive to changes in heat from the burners.



Fig. 11-5



Fig. 11-2 Warming rack in place inside oven



Fig. 11-3



Fig. 11-4

Placement of the grid lifter in cooking grid

## CARE & CLEANING

APPLIANCE MUST BE COMPLETELY COOL WHEN CLEANING. DO NOT SPRAY ANY CLEANER OR LIQUIDS ON THE APPLIANCE WHEN HOT.

The appliance *must* be cleaned as often as once a month (depending on use) to prevent grease build-up and other food deposits.

### INTERIOR

THE **BURNER PORTS** MUST BE KEPT CLEAN TO ENSURE PROPER IGNITION AND OPERATION.

Remove the burner (see orifice changing instructions) and clean the ports and slots as required. Also inspect and clean the burner inlet for insects and nests. A clogged burner can lead to a fire in the bottom of the appliance.

The inside of the appliance may be cleaned periodically with oven cleaner if desired. Follow the oven cleaner instructions for proper use.

Be careful not to get oven cleaner on the outside surface of the appliance as it can permanently damage the finish.

### EXTERIOR

Stainless steel surfaces when exposed to temperatures produced by the grilling process will change color. The stainless steel will change color from silver to brown and blue. This can be removed by using stainless steel cleaner.

Clean your appliance by first using grill cleaner to remove grease and dirt. Always wipe with the grain (See Fig. 12-1). Next, use stainless steel cleaner to restore the stainless steel color (Note: not for mirror finish). Finish by wiping your appliance down using polish wipes. **To clean any mirror finish (if applicable), use a quality brand glass cleaner only, not any of the cleaners mentioned above.**

If your appliance is installed in a seaside (salt air) or poolside (chlorine) location, it will be more susceptible to corrosion and must be maintained/cleaned more frequently. Do not store chemicals (such as chlorine or fertilizer) near your stainless steel appliance.

Due to the nature of stainless steel, surface iron oxide deposits may appear. Do not be alarmed – these deposits are removable with stainless steel cleaner through prompt and periodic maintenance. If not attended to promptly, permanent pitting may occur.

By following these recommendations, you will enjoy the beauty and convenience of your appliance for many years to come.



Fig. 12-1 - Wipe with grain

### PROTECTING YOUR APPLIANCE FROM THE WEATHER

An optional cover will protect your appliance when not in use. (Allow to cool before covering.)

Please specify the model number and serial number of your appliance when ordering a cover.

### IMPORTANT

**IN THE EVENT OF A GREASE FIRE, IMMEDIATELY SHUT OFF THE MAIN GAS VALVE TO THE GRILL. KEEP THE LID OPEN AND ALLOW THE FIRE TO EXTINGUISH ITSELF. A THOROUGH INSPECTION BY A TRAINED SERVICE TECHNICIAN SHOULD BE CONDUCTED BEFORE FUTURE USE OF YOUR GRILL. THE SERVICE TECHNICIAN WILL CHECK THE SYSTEM FOR GAS LEAKS AND WILL CHECK ALL ELECTRICAL WIRING FOR DAMAGE. ALL GAS LEAKS AND WIRING MUST BE REPAIRED PRIOR TO FUTURE USE.**

## TROUBLESHOOTING

If you have trouble with the unit, please use this list to identify the problem. By trying one or more of the solutions to the possible cause, you should be able to solve the problem. If this list does not cover your present problem, or if you have other technical difficulties with the unit, please contact your local dealer.

PROBLEM	POSSIBLE CAUSE	CORRECTION
<b>Ignition system failure</b>	1) Improper air shutter adjustment	1) Adjust air shutters.
	2) Ignition wire disconnected	2) Replug wires into generator.
	3) Low gas pressure	3) Have gas company check the operating pressure at the unit.
<b>Insufficient heat</b>	1) Improper air shutter adjustment	1) Adjust air shutters.
	2) Using propane orifice for natural gas	2) Change orifices.
	3) Low gas pressure/flame (natural)	3) Have gas company check the operating pressure at the unit.
	4) Low gas pressure/flame (propane)	4) Refill propane tank, or reset propane tank safety*: Shut off all valves (including propane tank) and follow lighting instructions exactly.
<b>Uneven heating</b>	1) Burner ports partially blocked by debris	1) Remove burners and clean out ports.
	2) Small spiders or insects in burner	2) Inspect burners for spider webs or other debris that may block gas flow.

**Note:** \*Propane tanks are equipped with a safety shutdown device that may cause low or no gas/flame at the burners if operating and lighting instructions are not followed exactly. If you suspect the propane tank safety shutoff is in effect, shut off all burner control valves and the propane tank valve. Then read and follow the LIGHTING INSTRUCTIONS exactly. Lighting instructions are located in the owner's manual. If the problem persists, continue troubleshooting, or contact your local dealer or distributor for assistance.

# WARRANTY

## PETERSON FIRE MAGIC GRILLS AND ACCESSORIES LIMITED WARRANTY

Robert H. Peterson Co. ("RHP") warrants your Fire Magic® grill to be free from defects in material and workmanship.

Fire Magic® cast stainless-steel burners, stainless-steel rod cooking grids, and stainless-steel housings are warranted for as long as you own your Fire Magic® grill -- **LIFETIME**. (Except as noted below.)

Fire Magic Choice stainless steel tubular burners are warranted for **TWENTY (20) YEARS**.

Fire Magic® cast brass burners, brass valves, inner liners, manifold assemblies, and backburner assemblies (except ignition parts) are warranted for **FIFTEEN (15) YEARS**.

Fire Magic® Electric Grills, including stainless steel grid, and housings are warranted for **TEN (10) YEARS**.

Fire Magic® Infra-red burners, flavor grids, Charcoal stainless steel grills, and Smokers are warranted for **FIVE (5) YEARS**; except for the charcoal pan, charcoal grid, wood pellet screen, thermometer, and ash tray; which are warranted for **ONE (1) YEAR**.

Fire Magic® sideburners and all other Fire Magic® grill components (except ignition and electronic parts) are warranted for **THREE (3) YEARS**.

Fire Magic® ignition systems (excluding batteries), electronic components (including lights and thermometers), and grill accessories are warranted for **ONE (1) YEAR**.

### A COPY OF YOUR SALES SLIP FOR PROOF OF PURCHASE IS REQUIRED

This warranty applies to the original purchaser for products which are installed in the United States or Canada and which are operated and maintained as intended for single family residential usage. This warranty is valid only with proof of purchase, shall commence on the date of purchase, and shall terminate (both as to original and any replacement products) on the anniversary date of the original purchase of the product stated on the above schedules.

This warranty covers defects in material and workmanship. This warranty **does not** cover parts which become defective as a result of negligence, misuse, use not in compliance with the Owner's Manual/Installation Instructions, accidental damage, improper handling, improper storage, improper installation, lack of required routine maintenance (as specified in the Owner's Manual/Installation Instructions), electrical damage, local gas impurities or failure to protect against combustibles. Product must be installed (and gas must be connected) as specified in the Owner's Manual/Installation Instructions by a **qualified professional installer**. Modifications to products which are not specifically authorized will void this warranty. Accessories, parts, valves, remotes, etc. when used must be Peterson products or this warranty is void. Warranted items will be repaired or replaced at Peterson's sole discretion. This warranty **does not** apply to rust, corrosion, oxidation, or discoloration unless the affected part becomes inoperable.

This warranty **does not** cover labor or labor related charges, except as provided by separate specific written programs from the Peterson Co. All repair work must be performed by a qualified professional service person and requires prior approval of Peterson.

Peterson may require the defective product or part to be returned to the factory to determine the cause of failure. Peterson will pay freight charges if the product or part is determined to be defective. This warranty does not cover breakage in shipment from our (Independent) distributor to its customer if the damage is determined to have occurred during that shipment.

This warranty specifically excludes liability for **indirect, incidental**, or consequential damages. Some states and provinces do not allow the exclusion or limitation of incidental or consequential damages, so the above exclusion may not apply to you. This warranty gives you specified legal rights, and you may have other rights that vary from state to state or province.

For additional information regarding this warranty, or to place a warranty claim, contact the R. H. Peterson dealer where the product was purchased.

**TO REGISTER YOUR PRODUCT ONLINE GO TO: [WWW.RHPETERSON.COM](http://WWW.RHPETERSON.COM),  
AND CLICK ON PRODUCT REGISTRATION. THANK YOU FOR YOUR PURCHASE.**

<b>Quality Check</b>			<b>Date:</b> _____		
<b>Burner Orifices</b>	Nat.	L.P.	<b>Leak Test:</b> _____	<b>Model#:</b> _____	
<b>Main:</b>	_____	_____	<b>Burn Test:</b> _____	<b>Serial#:</b> _____	
<b>Other:</b>	_____	_____	<b>Gas Type:</b> <u>Nat. / L.P.</u>	<b>Air Shutter:</b> _____	
				<b>Inspector:</b> _____	